

REGULATOR

RG90LN3/4XLN3/4 PO.23MBAR

15M3/H UPSO R.M., RV

CODE 500075

With an inlet pressure between 1 and 6bar, the regulator maintains the outlet pressure between 21 and 25mbar for flow rates between 1.5 and 15m3/h.



FEATURES

- **Inlet pressure:** 1-6bar
- **Output pressure:** 21-25mbar
- **Securities:** UPSO (17mbar) manual reset, RV(42-75mbar)
- **Nominal flow rate:** 15m3/h
- **Pressure tapping:** -
- **Connections:** LN3/4xLN3/4
- **Disposition:** 90°
- **Conduction for venting:** -

DIMENSIONS

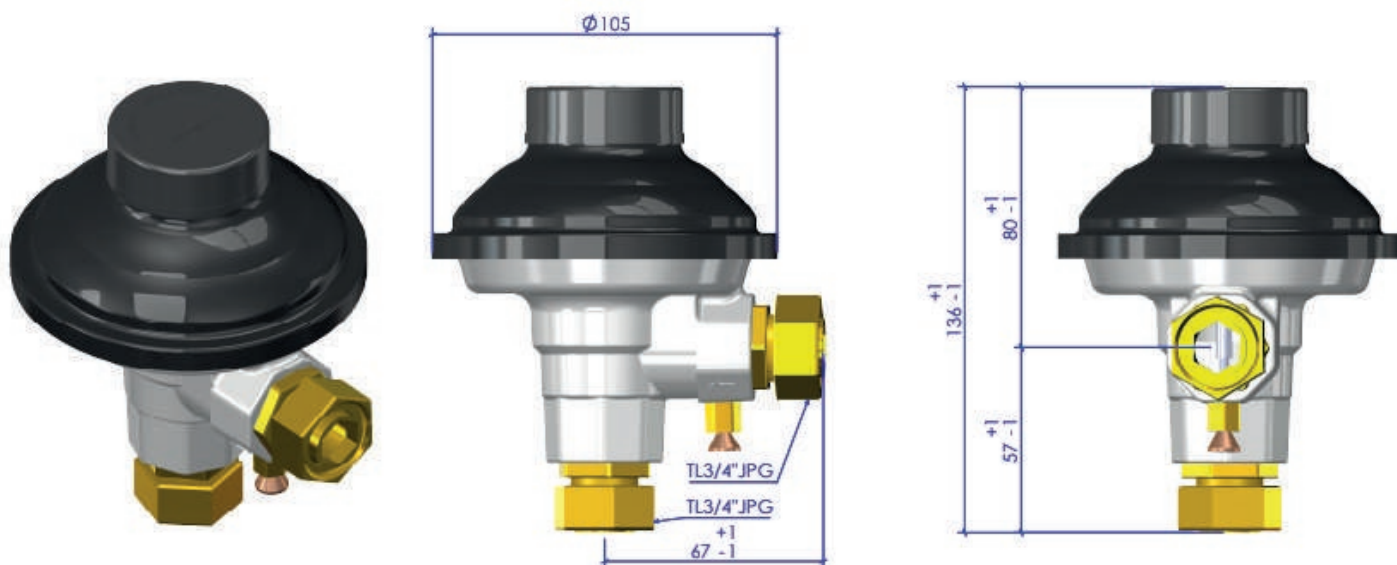

MATERIALS

- Membranes and seals, in NBR resistant to Liquefied Petroleum Gas (LPG), Natural Gas (NG) and Synthetic Natural Gas (SNG)
- Aluminum body
- Galvanized steel cover
- Cataphoresis treatment with high resistance on cover and body
- Galvanized steel springs
- Non-metallic internal parts, in PA with fiberglass and acetal resin (POM)
- Stainless steel filter
- Manufactured in the EU

COMPLIANCE WITH STANDARDS

According to EN 88-2:2007 and UNE13611:2019 and EN13611:2019/AC:2021

INSTALLATION AND COMMISSIONING

- ✓ Check the inlet pressure. It must not exceed 6 bar.
- ✓ Fit the regulator respecting the gas flow. See flow arrow on the bottom of the regulator.
- ✓ If the regulator has a relief line and is installed indoors, the relief must be piped to the outside through the corresponding pipe connection.
- ✓ Once the regulator has been installed, check that there are no leaks at the regulator connections.
- ✓ With all consumption points downstream of the regulator closed, open the gas tap upstream of the regulator.
- ✓ If the regulator is equipped with automatic VIS MIN, wait a few seconds (approx. 15-20) until the VIS is reset.
- ✓ In the case of manual VIS MIN, act on the reset device on the regulator (by pulling on it) for about 2 seconds.
- ✓ The controller will start to regulate when any consumption demand occurs.

BEHAVIOURAL CURVES

Pe: 1bar

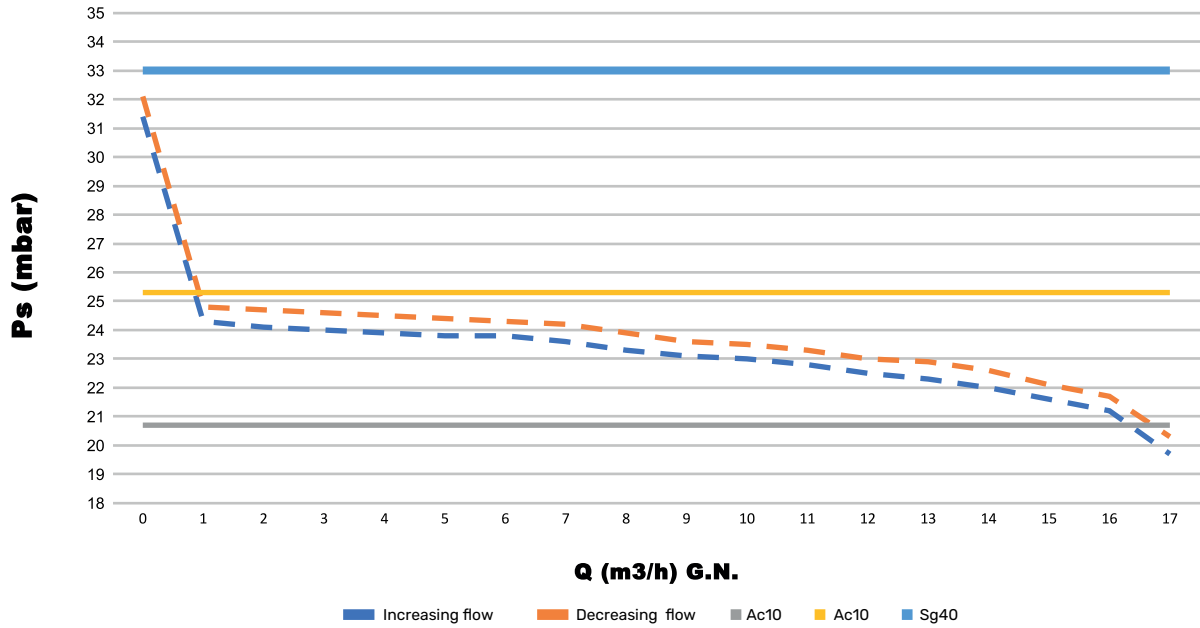

Pe: 2,5bar

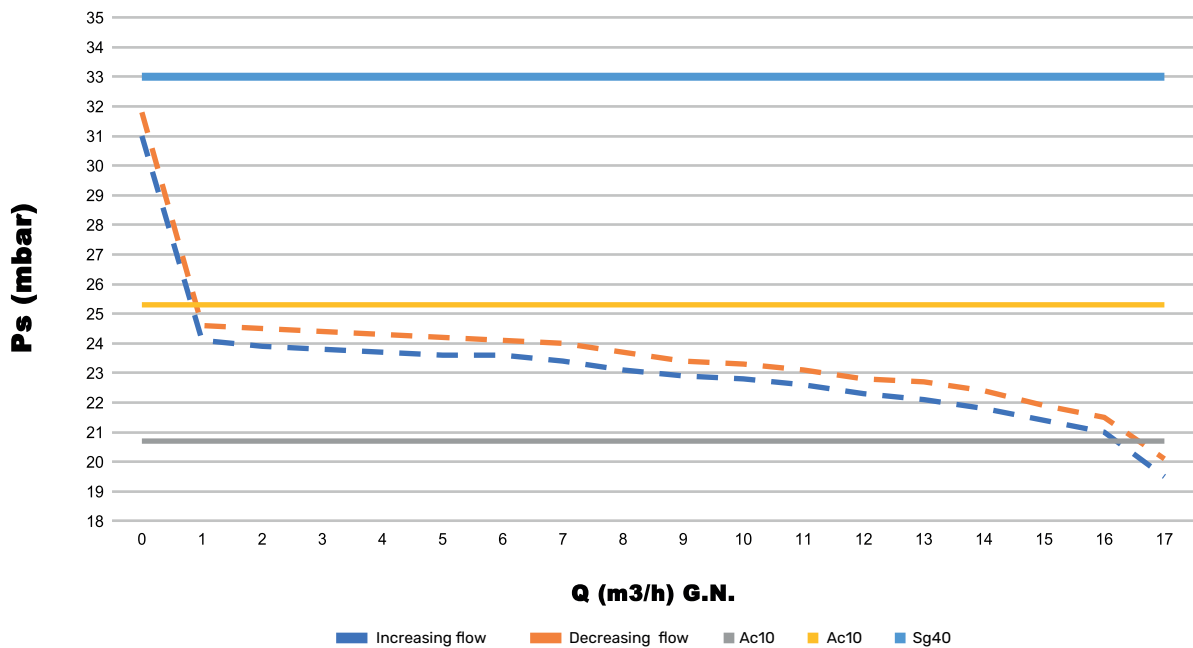

BEHAVIOURAL CURVES

Pe: 5bar

